

Sprocket for Double Pitch Chain

双节距链条用链轮

DBC 2040

S-Roller Type : A2040, C2040

unit : mm

No. of Teeth 轮齿数量 N	Outside Dia 齿顶直径 DO	Pitch Dia 节距 DP	Pilot Bore 标准径 d		Hub Dia 凸轮轴直径 DH	Length thru Bore 长度 L	Approx. Weight 平均重量(Kg)	
			Min	Max			Type-B	Type-A
11	51	46.96	11	18	30	25	0.20	
12	55	50.80	11	22	34	25	0.22	
13	59	54.66	15	24	38	25	0.25	
14	63	58.55	15	26	42	25	0.33	
15	67	62.43	15	28	46	25	0.35	
16	71	66.37	15	30	50	25	0.45	
17	75	70.31	15	32	54	30	0.55	
18	80	74.27	15	32	54	30	0.63	
19	84	78.23	15	32	54	30	0.65	
20	88	82.20	15	32	56	40	0.75	
21	92	86.17	15	32	56	40	0.80	
22	96	90.16	15	32	56	40	0.93	
23	100	94.15	15	32	56	40	1.05	
24	104	98.14	15	32	56	40	1.10	
25	108	102.14	15	32	56	40	1.15	
26	112	106.14	15	32	56	40	1.20	
27	116	110.14	15	40	65	40	1.25	
28	120	114.15	15	40	65	40	1.30	
29	124	118.16	15	40	65	40	1.40	
30	129	122.17	15	40	65	40	1.50	

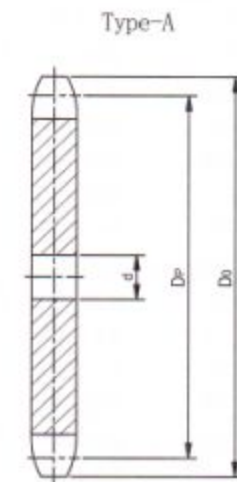

R-Roller Type (Over size Roller Type) : C2042

unit : mm

No. of Teeth 轮齿数量 N	Outside Dia 齿顶直径 DO	Pitch Dia 节距 DP	Pilot Bore 标准径 d		Hub Dia 凸轮轴直径 DH	Length thru Bore 长度 L	Approx. Weight 平均重量(Kg)	
			Min	Max			Type-B	Type-A
8	77	66.37	16	33	48	30	0.60	
9	85	74.73	16	35	56	30	0.70	
10	93	82.19	20	35	56	40	0.98	
11	102	90.16	20	35	56	40	1.00	
12	110	98.14	20	35	56	40	1.10	
13	118	106.14	20	40	65	40	1.60	
14	127	114.15	20	40	65	40	1.70	
15	134	122.17	20	40	65	40	1.75	
16	142	130.20	20	40	65	40	2.00	0.69
17	150	138.23	20	45	70	45	2.10	0.84
18	160	146.27	20	45	70	45	2.15	0.91
19	168	154.32	20	45	70	45	2.30	0.99
20	176	162.37	20	45	70	45	2.50	1.07
21	184	170.43	20	55	89	45	2.60	1.24
22	192	178.49	20	55	89	45	2.70	1.36
23	199	186.54	20	55	89	45	2.80	1.47
24	208	194.59	20	55	89	45	2.90	1.59
25	216	202.67	20	55	89	45	3.00	1.73
26	225	210.72	20	55	89	45	3.10	1.91
28	241	218.80	20	55	89	45	3.20	2.18
30	257	226.87	20	55	89	45	3.40	2.41

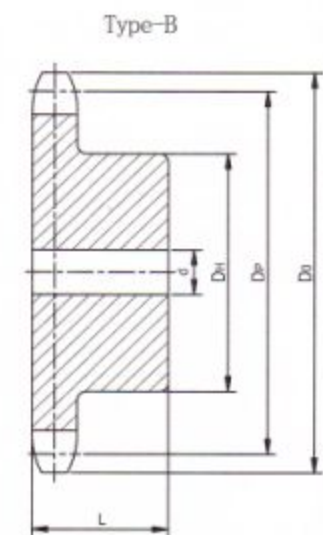

DBC 2050

S-Roller Type : A2050, C2050

unit : mm

No. of Teeth 轮齿数量 N	Outside Dia 齿顶直径 DO	Pitch Dia 节圆 DP	Pilot Bore 标准径 d		Hub Dia 凸轮轴直径 DH	Length thru Bore 长度 L	Approx. Weight 平均重量(Kg)	
			Min	Max			Type-B	Type-A
11	63	58.72	15	22	37	25	0.30	
12	69	63.50	15	26	43	25	0.40	
13	74	68.33	15	30	48	30	0.50	
14	79	73.18	15	33	53	30	0.60	
15	84	78.05	15	37	58	30	0.70	
16	89	82.96	15	40	63	30	0.80	
17	94	87.88	15	40	65	40	0.95	
18	100	92.84	15	40	65	40	1.20	
19	104	97.79	15	40	65	40	1.30	
20	110	102.75	15	45	70	45	1.60	
21	115	107.75	15	45	70	45	1.75	
22	120	112.70	17	45	70	45	1.80	
23	125	117.68	17	46	70	45	1.85	
24	130	122.67	17	45	70	45	1.90	
25	135	127.67	17	45	70	45	2.00	
26	140	132.67	17	45	70	45	2.10	
27	145	137.67	17	45	70	45	2.20	
28	150	142.68	17	45	70	45	2.35	
29	155	147.69	17	45	70	45	2.50	
30	161	152.70	17	45	70	45	2.60	

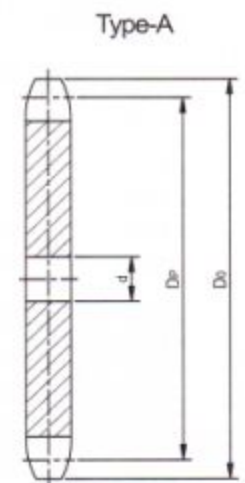

R-Roller Type (Over size Roller Type) : C2052

unit : mm

No. of Teeth 轮齿数量 N	Outside Dia 齿顶直径 DO	Pitch Dia 节圆 DP	Pilot Bore 标准径 d		Hub Dia 凸轮轴直径 DH	Length thru Bore 长度 L	Approx. Weight 平均重量(Kg)	
			Min	Max			Type-B	Type-A
8	96	82.96	20	40	69	30	1.20	
9	106	92.84	20	45	70	30	1.40	
10	116	102.74	20	45	70	45	1.90	
11	127	112.70	20	45	70	45	2.00	
12	138	122.67	20	45	70	45	2.20	0.82
13	148	132.67	20	45	70	45	2.30	0.95
14	158	142.68	20	45	70	45	2.40	1.04
15	168	152.71	20	45	70	45	2.50	1.23
16	179	162.74	20	45	70	45	2.70	1.41
17	189	172.79	20	50	85	50	3.00	1.59
18	199	182.84	20	55	90	55	4.00	1.77
19	209	192.90	20	55	90	55	4.30	2.04
20	220	202.96	20	55	90	55	4.40	2.14
21	230	213.03	20	55	90	55	4.60	2.41
22	240	223.09	20	55	90	55	4.80	2.59
23	250	233.17	20	55	90	55	4.90	2.86
24	260	243.26	20	55	90	55	5.00	3.18
25	270	253.31	20	55	90	55	5.50	3.41
26	280	263.40	20	55	90	55	6.00	3.64
28	301	283.51	20	55	90	55	6.80	4.18
30	321	303.73	20	55	90	55	7.00	4.91

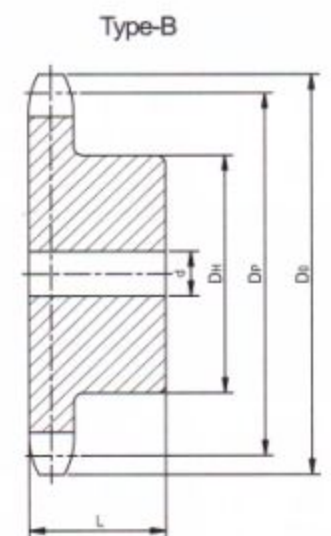

Sprocket for Double Pitch Chain

双节距链条用链轮

DBC 2060

S-Roller Type A2060, C2060

unit : mm

No. of Teeth 轮齿数量 N	Outside Dia 齿顶直径 DO	Pitch Dia 节距 DP	Pilot Bore 标准径 d		Hub Dia 凸轮的直径 DH	Length thru Bore 长度 L	Approx. Weight (Kg) 平均重量(Kg) Type-B
			Min	Max			
11	76	70.46	15	27	45	40	0.70
12	83	76.20	15	31	51	40	0.80
13	88	81.99	15	35	56	40	0.90
14	95	87.81	17	35	56	40	1.00
15	101	93.68	17	35	56	40	1.10
16	107	99.57	17	35	56	40	1.20
17	113	105.46	17	45	70	40	1.60
18	119	111.40	17	45	70	40	1.90
19	125	117.35	17	45	70	40	2.10
20	132	124.30	17	50	80	45	2.40
21	138	129.26	17	50	80	45	2.50
22	144	135.24	17	50	80	45	2.60
23	150	141.22	17	50	80	45	2.80
24	156	147.21	17	50	80	45	3.00
25	162	153.20	17	50	80	45	3.20
26	168	159.20	17	50	80	45	3.30
27	174	165.21	17	50	80	45	3.50
28	181	171.22	17	50	80	45	3.60
29	187	177.23	17	50	80	45	3.70
30	193	183.26	17	50	80	45	4.00

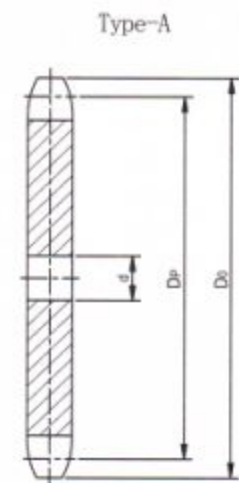

R-Roller Type (Over size Roller Type) : C2062

unit : mm

No. of Teeth 轮齿数量 N	Outside Dia 齿顶直径 DO	Pitch Dia 节距 DP	Pilot Bore 标准径 d		Hub Dia 凸轮的直径 DH	Length thru Bore 长度 L	Approx. Weight 平均重量(Kg)	
			Min	Max			Type - B	Type - A
8	115	99.57	20	47	72	32	2.00	
9	128	111.40	20	50	80	32	2.23	
10	140	123.29	26	50	80	45	2.40	
11	153	135.24	26	50	80	45	2.60	
12	165	147.21	26	50	80	45	2.80	1.45
13	177	159.20	26	55	85	50	3.10	1.59
14	190	171.22	26	55	85	50	3.70	1.82
15	202	183.25	26	55	85	50	3.80	2.14
16	214	195.29	26	55	85	55	4.10	2.41
17	227	207.35	26	60	90	55	4.90	2.73
18	239	219.41	26	60	90	55	5.30	3.09
19	251	231.48	26	60	90	55	5.60	3.41
20	263	243.55	26	60	90	55	6.00	3.77
21	276	255.63	26	60	90	55	6.36	4.18
22	287	267.72	26	60	90	55	6.68	4.45
23	300	279.81	26	60	90	55	7.27	4.91
24	312	291.19	26	60	90	55	7.73	5.23
25	324	303.99	26	60	90	55	8.64	5.68
26	337	316.08	26	60	90	55	10.00	6.18
28	361	340.28	26	60	90	55	10.91	7.18
30	385	364.49	26	60	90	55	12.27	8.18

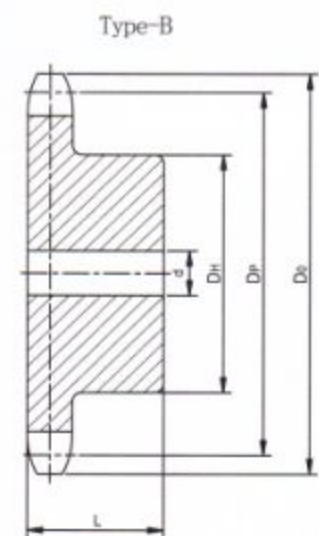

DBC 2080

S-Roller Type : A2080, C2080

unit : mm

No. of Teeth 齿数	Outside Dia 齿顶圆直径	Pitch Dia 节圆直径	Pilot Bore 导孔直径		Hub Dia 凸轮轴直径	Length thru Bore 长度	Approx. Weight	
			d				Type-B	Type-A
N	DO	DP	Min	Max	DH	L		
11	101	93.95	18	38	60	50	1.70	
12	110	101.60	18	45	69	50	1.90	
13	118	109.32	18	48	77	50	2.10	
14	126	117.09	18	50	80	50	2.40	
15	134	124.89	22	50	80	50	2.60	
16	143	132.74	22	50	80	50	3.00	
17	151	140.61	22	60	90	50	3.30	
18	159	148.54	22	60	90	50	3.50	
19	167	156.46	22	60	90	50	3.70	
20	176	164.39	22	60	90	50	4.30	
21	184	172.35	25	60	90	50	4.40	
22	192	180.31	25	60	93	50	4.70	
23	200	188.29	25	60	93	50	5.00	
24	208	196.28	25	60	93	50	5.30	
25	216	204.27	25	60	93	50	5.60	
26	224	212.27	25	60	93	50	5.90	
27	233	220.28	25	60	93	50	6.20	
28	241	228.30	25	60	93	50	6.50	
29	249	236.31	25	60	93	50	6.90	
30	257	244.35	25	60	93	50	7.20	

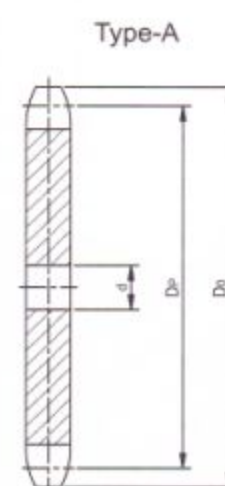

R-Roller Type (Over size Roller Type) : C2082

unit : mm

No. of Teeth 齿数	Outside Dia 齿顶圆直径	Pitch Dia 节圆直径	Pilot Bore 导孔直径		Hub Dia 凸轮轴直径	Length thru Bore 长度	Approx. Weight	
			d				Type - B	Type - A
N	DO	DP	Min	Max	DH	L		
8	153	132.74	25	60	95	45	3.18	
9	170	148.54	25	70	108	45	4.09	
10	334	164.39	25	70	108	45	5.00	
11	203	180.31	25	70	108	45	5.91	
12	220	196.26	25	70	108	45	6.82	
13	236	212.27	32	80	120	55	7.73	
14	253	228.29	32	80	120	55	8.64	
15	269	244.35	32	80	120	55	9.09	
16	286	260.04	32	80	120	55	10.00	
17	302	276.48	32	80	120	55	10.45	
18	318	292.56	32	80	120	55	11.82	
19	335	308.63	32	80	120	55	12.73	
20	351	324.74	32	80	120	55	13.64	
21	367	340.84	32	80	120	55	14.09	
22	384	356.95	32	80	120	55	14.54	
23	400	373.07	32	80	120	55	15.45	
24	416	389.20	32	80	120	55	17.73	
25	432	405.33	32	80	120	55	18.64	
26	449	421.46	32	85	130	55	19.54	
28	481	453.72	32	85	130	55	20.45	
30	514	486.00	32	85	130	55	21.36	

